

Agilent 7500 Series ICP-MS Customer Maintenance Parts List



Agilent Technologies



Agilent Technologies

Notices

Copyright © 2006 Agilent Technologies

No part of this manual may be reproduced in any form or by any means (including electronic storage and retrieval or translation into a foreign language) without prior agreement and written consent from Agilent Technologies, Inc. as governed by United States and international copyright laws.

Manual Part Number

G3270-90123

Edition

Rev.B, December 2006

Printed in Japan

Agilent Technologies, Inc.
9-1 Takakura-cho, Hachioji-shi,
Tokyo 192-8510 Japan

Warranty

The material contained in this document is provided “as is,” and is subject to being changed, without notice, in future editions. Further, to the maximum extent permitted by applicable law, Agilent disclaims all warranties, either express or implied, with regard to this manual and any information contained herein, including but not limited to the implied warranties of merchantability and fitness for a particular purpose. Agilent shall not be liable for errors or for incidental or consequential damages in connection with the furnishing, use, or performance of this document or of any information contained herein. Should Agilent and the user have a separate written agreement with warranty terms covering the material in this document that conflict with these terms, the warranty terms in the separate agreement shall control.

Technology Licenses

The hardware and/or software described in this document are furnished under a license and may be used or copied only in accordance with the terms of such license.

Restricted Rights Legend

If software is for use in the performance of a U.S. Government prime contract or subcontract, Software is delivered and licensed as “Commercial computer software” as defined in DFAR 252.227-7014 (June 1995), or as a “commercial item” as defined in

FAR 2.101(a) or as “Restricted computer software” as defined in FAR 52.227-19 (June 1987) or any equivalent agency regulation or contract clause. Use, duplication or disclosure of Software is subject to Agilent Technologies’ standard commercial license terms, and non-DOD Departments and Agencies of the U.S. Government will receive no greater than Restricted Rights as defined in FAR 52.227-19(c)(1-2) (June 1987). U.S. Government users will receive no greater than Limited Rights as defined in FAR 52.227-14 (June 1987) or DFAR 252.227-7015 (b)(2) (November 1995), as applicable in any technical data.

Safety Notices

CAUTION



A **CAUTION** notice denotes a hazard. It calls attention to an operating procedure, practice, or the like that, if not correctly performed or adhered to, could result in damage to the product or loss of important data. Do not proceed beyond a **CAUTION** notice until the indicated conditions are fully understood and met.

WARNING



A **WARNING** notice denotes a hazard. It calls attention to an operating procedure, practice, or the like that, if not correctly performed or adhered to, could result in personal injury or death. Do not proceed beyond a **WARNING** notice until the indicated conditions are fully understood and met.

**Agilent 7500 Series ICP-MS
Customer Maintenance
Parts List**

Contents

Preface

About the Maintenance Parts P-2

Conventions Used in This Book P-3

Where to Go for More Information P-4

Agilent Technologies on the Internet P-4

1 Parts Related to the Peristaltic Pump

Parts Related to the Peristaltic Pump 1-2

2 Parts Related to the Nebulizer

Parts for the Babington Nebulizer 2-2

Parts for the Concentric Nebulizer 2-4

Parts for the Micro Flow Nebulizers 2-6

Parts for the MicroMist Nebulizer 2-8

Burgener Research Mira Mist Nebulizer 2-9

Parts Related to the PFA Concentric Nebulizer 2-10

Parts for the Cross Flow Nebulizer 2-12

Miscellaneous parts for Nebulizer 2-14

3 Parts Related to the Spray Chamber

Parts Related to the Spray Chamber 3-2

Agilent 7500 Series ICP-MS Customer Maintenance Parts List
Contents

4 Parts Related to the Torch

Parts Related to the Torch 4-2

5 Parts Related to the Interface

Parts Related to the Interface 5-2

6 Parts Related to the Ion Lens and Vacuum Chamber

Parts Related to the Ion Lens and Vacuum Chamber 6-2

7 Parts Related to the 7500ce

Parts Related to the 7500ce 7-2

8 Parts Related to the 7500cs

Parts Related to the 7500cs 8-2

9 Miscellaneous Components

Miscellaneous Components 9-2

10 Parts related to the Integrated Sample Introduction System (ISIS)

Parts Related to the Integrated Sample Introduction System (ISIS) 10-2

Parts Related to the Hydride Generator Accessory 10-7

Agilent 7500 Series ICP-MS Customer Maintenance Parts List
Contents

11 Parts Related to the GC-ICP-MS Interface

Parts Related to the GC-ICP-MS Interface 11-2

12 Parts Related to the Integrated Auto Sampler (I-AS)

Parts Related to the I-AS (Integrated Auto Sampler) 12-2

13 Parts Related to the ASX-500 Series ICP-MS Autosampler

Parts Related to the Agilent ASX-500 Series ICP-MS Autosampler 13-2

Agilent 7500 Series ICP-MS Customer Maintenance Parts List
Contents



Preface

Preface

Preface

The *Agilent 7500 Series ICP-MS Customer Maintenance Parts List* explains the maintenance parts for use with the Agilent 7500, the Integrated Sample Introduction System (ISIS), Integrated Auto Sampler (I-AS), GC-ICP-MS Interface and the ASX-500 Series ICP-MS Autosampler.

About the Maintenance Parts

It is important to maintain the Agilent 7500 regularly to extend the useful life of its components and optimize its analytical capabilities, including the periodical replacement of parts.

Please contact your local Agilent office when ordering parts, and please confirm the correct part number for replacement.

Preface

Conventions Used in This Book

This book uses certain conventions to distinguish different types of information easily. This section describes these conventions.

Notes

Notes contain a reminder about the effect of particular actions. They are indicated as follows:

NOTE

This example shows how a note is displayed.

Cautions

Cautions indicate situations that could overwrite data or require immediate attention to prevent harm to the instrument. Cautions are indicated as follows:

CAUTION



This example shows how a caution is displayed.

Warnings

Warnings indicate situations that could cause bodily harm. Warnings are indicated as follows:

WARNING



This example shows how a warning is displayed.

Preface

Where to Go for More Information

In addition to the *Agilent 7500 Series ICP-MS Customer Maintenance Parts List*, you can reference the following resources:

- *Agilent 7500 Series ICP-MS ChemStation Operator's Manual*
- *Agilent 7500 Series ICP-MS Hardware Manual*
- *Agilent 7500 Series ICP-MS Tuning and Application Handbook*
- *Agilent 7500 Series ICP-MS Option Instruction Manual*
- *Online Help*
- *Integrated Autosampler Manual*
- *GC-ICP-MS Interface Manual*

Your computer system has additional manuals that document the software and hardware. For more information on using or maintaining your computer, printer, or peripheral equipment, consult the respective hardware user's guide. Microsoft® Windows™ has a user's guide that explains how to install, use, and troubleshoot the software.

Agilent Technologies on the Internet

You can get information about applications, peripherals and the core products at www.agilent.com/chem/icpms. The patch file to update the ChemStation to the latest revision can also be downloaded from the same URL.

Notice of Trademarks

Tygon® and PharMed® are registered trademarks of Norton Performance Plastics Corporation.

Teflon® is a registered trademark of E. I. DuPont de Nemours and Company.

Viton® is a registered trademark of DuPont Dow Elastomers, L.L.C.

Parts Related to the Peristaltic Pump

Parts Related to the Peristaltic Pump

Parts Related to the Peristaltic Pump

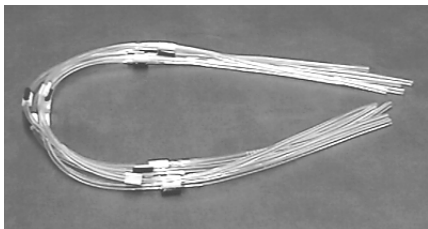

Peristaltic Pump Tubing for Sample Introduction
(Tygon Tubing, 1.02mm id, 12/pk)
P/N : G1833-65569

This tubing is the standard peristaltic pump tubing for sample introduction. It can be used for introducing many sample types such as nitric acid and hydrofluoric acid, but cannot be used for introducing organic solvents.



Peristaltic Pump Tubing for Drainage
(PharMed Tubing, 1.52mm id, 12/pk)
P/N : G1833-65570

This tubing is the standard peristaltic pump tubing for drainage. It has a long lifetime, but cannot be used for sample introduction because its impurity level is high. This tubing has stronger stoppers than the existing tubing (G1820-65216). This tubing is also Organic resistant.



Peristaltic Pump Tubing for ISTD
(Tygon Tubing, 0.19mm id, 12/pk)
P/N : G1833-65571

This tubing is used for online internal standard addition.

Agilent 7500 Series ICP-MS Customer Maintenance Parts List
Parts Related to the Peristaltic Pump

Online ISTD Addition Kit
P/N : G1833-65071

The online ISTD (internal standard) addition kit allows mixing of the sample solution with the internal standard solution at a fixed rate using the peristaltic pump. When Internal Standard is not used, install the Plug for the cross joint into the cross joint.

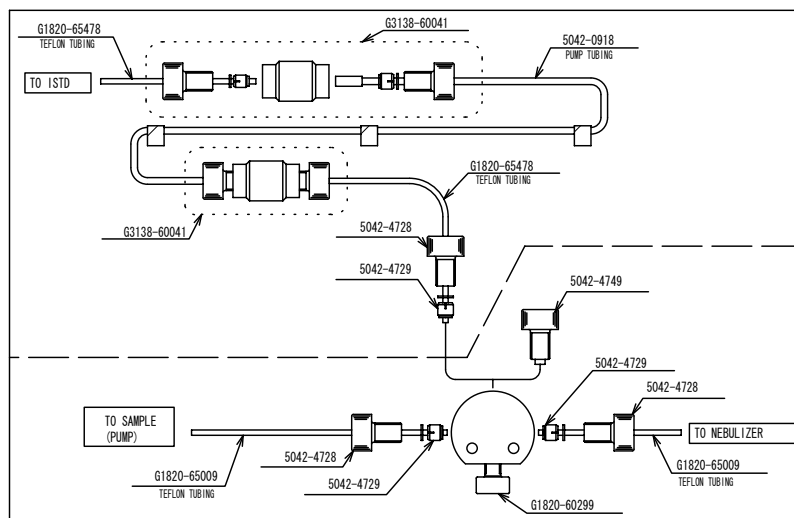
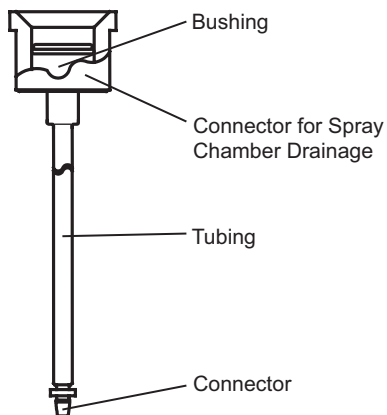

Table 1-1 Kit Contents

Description	QTY	P/N in drawing	P/N for Ordering
Peristaltic Pump Tubing	2	5042-0918	G1833-65571
Tubing Adapter	2	G3138-60041	G3138-65158
Sample Tubing	1	G1820-65478	G1820-65478
Plug for Cross Joint	1	5042-4749	G3138-65129
Sample Tubing	1	G1820-65009	G1820-65009
Teflon Nut	5	5042-4728	5064-8023
Front and Back Ferrule	5	5042-4729	5064-8024
Cross Joint	1	G1833-60299	G1833-65579*

* for H₂O₂ Sample : G1833-65580

Parts Related to the Peristaltic Pump



Drain Tubing Kit

P/N : G1833-65411

This tubing kit is used to drain the spray chamber to waste. Use the bushing for organic solvent (G1820-65504) when organic solvent is introduced.

Description :

Connector for Spray Chamber Drainage

Bushing (Viton O-ring)

Tubing (4.0mm id, 120mm)

Connector

**Connector for Spray Chamber Drainage
(Polypropylene)**

P/N : G1820-65503

Bushing

P/N : G1820-65482, Viton, 5/pk

G1820-65504, for Organic Solvent, 1/pk



Tubing for Drainage (4.0mm id, 2.5m)

P/N : G1820-65515, Organic resistant



Drain Tank

P/N : 5042-4769 (4 liter)

G1820-65016 (1 liter)

G1820-65505 (for Organic Solvent)

5042-4769 : Polyethelene

G1820-65016 : with Polyvinyl Chloride Connector

G1820-65505 : with Polypropylene Connector

Photo : 5042-4769

Agilent 7500 Series ICP-MS Customer Maintenance Parts List
Parts Related to the Peristaltic Pump



Tubing Cutter
P/N : 8710-1930

Agilent 7500 Series ICP-MS Customer Maintenance Parts List
Parts Related to the Peristaltic Pump

Parts Related to the Nebulizer

Parts for the Babington Nebulizer



Babington Nebulizer
(with Viton O-ring and Sample Tubing, PEEK)
P/N : G1820-60453

The Babington nebulizer can be used for introducing samples with high matrix and high TDS (total dissolved salts) level samples.

Parts required for Babington Nebulizer



End Cap for Babington Nebulizer
(with Viton O-ring, Polypropylene)
P/N : G1833-65476

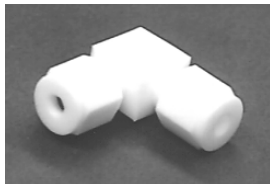

Carrier Gas Line Connector for Babington Nebulizer
(with ferrule and Viton O-ring, Teflon)
P/N : G1820-65214

The port with the o-ring connects with the nebulizer, and the port with the ferrule connects with the carrier gas line tubing.

Parts Related to the Nebulizer



Sample Tubing with Connector for Babington Nebulizer (Teflon)

P/N : G1820-65276

This tool is used for removing and installing the sample tubing into the Babington nebulizer.



Babington Nebulizer Removal Tool

P/N : G1820-65345

This tool is used to remove the Babington nebulizer from the end cap.



O-rings for Babington Nebulizer (Viton O-rings, 4/pk)

P/N : G1820-65199

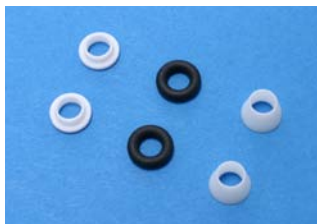

Ferrule and Viton O-ring Kit for Carrier Gas Line Connector for Babington/Concentric Nebulizer

P/N : G1820-65533

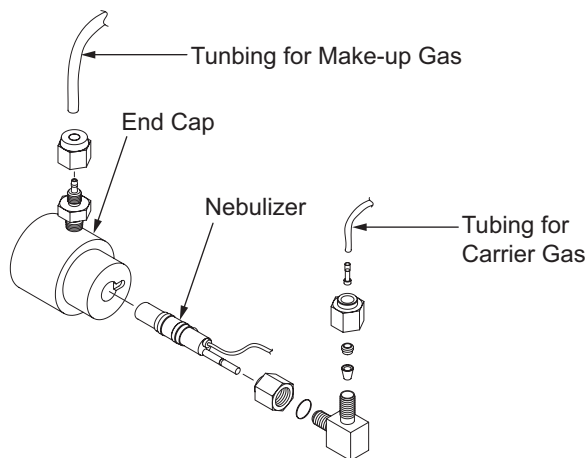
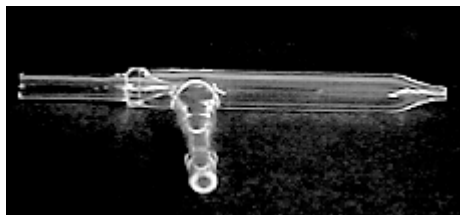

Figure: Babington Nebulizer and Connector, End Cap

Parts Related to the Nebulizer

Parts for the Concentric Nebulizer



Concentric Nebulizer (Quartz)

P/N : G1820-65138

This nebulizer is recommended for trace analysis and introducing organic solvents. The inner capillary can be clogged from particles or high concentrations of salt.

Concentric Nebulizer (Pyrex)

P/N : G1820-65030

Parts required for Concentric Nebulizer



End Cap for Concentric Nebulizer

(with Viton O-rings, PTFE)

P/N : G1833-65475

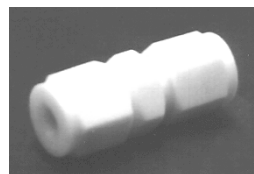

Carrier Gas Line Connector for Concentric Nebulizer
(with ferrule and Viton O-ring, Teflon)

P/N : G1820-65052

The port with the o-ring connects with the nebulizer, and the port with the ferrule connects with the carrier gas line tubing.



Sample Line Connector for Concentric Nebulizer
(with Viton O-ring)

P/N : G1820-60160

The port with the larger hole connects with the nebulizer, and the port with the smaller hole connects with the sample line tubing.

Parts Related to the Nebulizer



O-ring Kit for Concentric Nebulizer
(Viton O-rings, 2 types, 10ea.)
P/N : G1820-65491



O-ring kit
P/N: G1820-65075

Viton o-rings, 2 sizes, 2 ea.

These o-rings are used for the end cap for the concentric nebulizer. The smaller o-rings seal between the concentric nebulizer and the center hole of the end cap, and the larger o-rings seal between the end cap and spray chamber.

Replacement is required when the o-ring is damaged and the seal is no longer good.

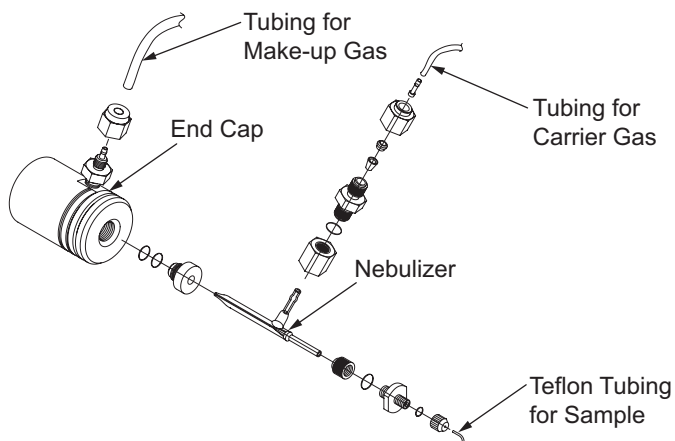

Figure: Concentric Nebulizer and Connector, End Cap

Parts Related to the Nebulizer

Parts for the Micro Flow Nebulizers



Agilent Micro Flow Nebulizer

- P/N : G3139A#011 MFN100 (100-200 μ l/min)**
G3139A#012 MFN20 (20-40 μ l/min)
G3139A#021 MFN100 for I-AS (100-200 μ l/min)
G3139A#022 MFN20 for I-AS (20-40 μ l/min)
G3139A#131 MFN100 for ASX-500
(100-200 μ l/min)
() approximate flow rate.

This is an all fluoropolymer, low-flow, reliable nebulizer. This nebulizer is used for many sample types including low volume samples, aggressive chemicals and solvent, organic solvent, etc. This nebulizer can be used with G3139A#301. It can be also used with the concentric end cap (G1833-65475) and Spray Chamber (G1820-65337 or G1833-65463).

HF Kit for the Micro Flow Nebulizer

P/N : G3139A#301

Contents

- G3139-65002 End Cap
- G3139-65003 Spray Chamber
- G3139-65004 Connector
- G3139-65006 Inert Torch (without Injector, Quartz)
- G3139-65005 Injector for Inert Torch, Platinum, 2.0mm id



End Cap for the Agilent Micro Flow Nebulizer

P/N : G3139-65002

This is an End Cap for the Agilent Micro Flow Nebulizer. O-rings are not required to seal the connection to the Spray Chamber.

Agilent 7500 Series ICP-MS Customer Maintenance Parts List

Parts Related to the Nebulizer



Spray Chamber for Agilent Micro Flow Nebulizer (PFA)

P/N : G3139-65003

This PFA spray chamber is the standard spray chamber for the inert sample introduction kit, and is used when aspirating hydrofluoric acid.



Connector for Agilent Micro Flow Nebulizer

P/N : G3139-65004

This connector is used to connect the PFA spray chamber to the torch and is used when aspirating hydrofluoric acid. O-rings are not required to seal the connection between the spray chamber and the injector of the inert torch.



Inert Torch (without Injector, Quartz) for the Agilent Micro Flow Nebulizer

P/N : G3139-65006

This torch is used with a platinum injector for the inert torch assembly. The inert torch assembly is used when aspirating hydrofluoric acid.



Injector of Inert Torch for the Agilent Micro Flow Nebulizer

P/N : G3139-65005

This injector is used with the inert torch assembly. The inert torch assembly is used when aspirating hydrofluoric acid.

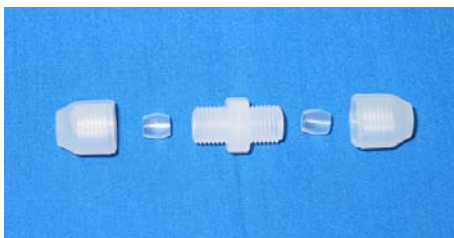

Union for Carrier Gas Line (2/pk)

P/N : G1833-65583

Parts for the MicroMist Nebulizer



MicroMist Nebulizer

P/N: G3266A#001

Contents

MicroMist Nebulizer

EzyLok Connector

This must be used with the concentric End Cap
(G1833-65475)

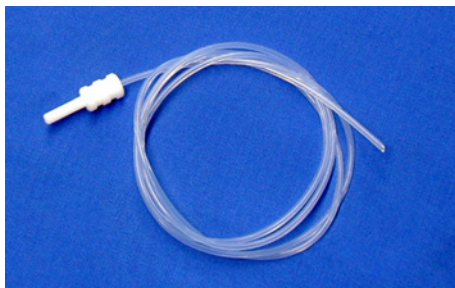

Sample Tubing for the MicroMist Nebulizer (700mm, with Connector, 10/pk)

P/N: G3266-80010, 0.25mm id

G3266-80011, 0.5mm id



EzyLok Connector

P/N: G3266-80015

Burgener Research Mira Mist Nebulizer

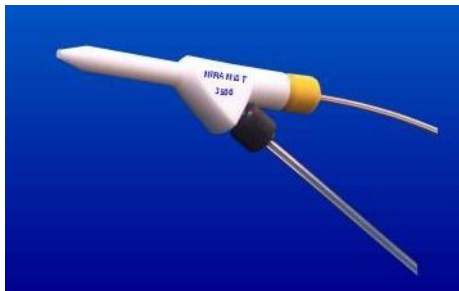

Burgener Research Mira Mist Nebulizer

P/N : G3161A#001 Teflon

P/N : G3161A#002 PEEK

Photo: Mira Mist Nebulizer Teflon

This nebulizer is for Environmental samples. It must be used with the concentric End Cap (G1833-65475) and Spray Chamber (G1820-65337 or G1833-65463).

Parts Related to the Nebulizer

Parts Related to the PFA Concentric Nebulizer



PFA Concentric Nebulizer (made of PFA)

**P/N: G3285-80000 (200 μ L/min)
G3285-80001 (200 μ L/min, with I-AS probe attachment)**

A low flow nebulizer made of 100% fluorocarbon resin. This nebulizer has high stability and can be used with various acids, alkali samples and organic solvents. Inert Sample Introduction Kit also available (G3285-80010, G3285-80011, G3285-80012 and G3285-80013). End cap can also be used with the concentric nebulizer (G1833-65475).



Union Connector (tube diameter 4.0 mm)

P/N: 5064-8078

Used to connect the carrier gas tube to the PFA concentric nebulizer.



Inert Sample Introduction Kit

**P/N: G3285A#101 (2.5 mm id Sapphire injector)
G3285A#102 (2.5 mm id Platinum injector)
G3285A#103 (1.5 mm id Sapphire injector)
G3285A#104 (1.5 mm id Platinum injector)**

Kit components:

- End cap
- Spray chamber
- Drain tube
- Connector tube
- Injector
- Torch
- Bracket

The 1.5 mm injector comes with a port for option gas which can be used for oxygen gas when using organic solvent. For Agilent 7500 with serial number JP51201712 or before, it is necessary to change to the new bracket which is provided.

Agilent 7500 Series ICP-MS Customer Maintenance Parts List

Parts Related to the Nebulizer

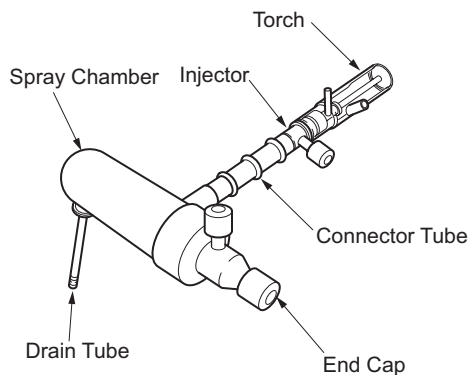

Order numbers for the components of the Inert Sample Introduction Kit are as follows.

End Cap (PFA)

P/N: G3285-80020

Spray Chamber (PFA)

P/N: G3285-80021

Drain Tube (PFA)

P/N: G3285-80022

Connector Tube (PFA)

P/N: G3285-80023

Injector (O-ring attached)

P/N: G3285-80030 (2.5 mm id Sapphire injector)

G3285-80031 (2.5 mm id Platinum injector)

G3285-80032 (1.5 mm id Sapphire injector)

G3285-80033 (1.5 mm id Platinum injector)

The 1.5 mm injector comes with a port for option gas which can be used for oxygen gas when using organic solvent.

Torch (Quartz)

P/N: G3285-80050

Parts Related to the Nebulizer

Parts for the Cross Flow Nebulizer



Cross Flow Nebulizer

P/N : G1833-65462

The cross flow nebulizer is the standard nebulizer for the inert sample introduction kit, and is used for introducing hydrofluoric acid.



Makeup Gas Line Connector for the Cross Flow Nebulizer (Luer Type, Polypropylene)

P/N : G1833-65477



Makeup Gas Line Connector for the Cross Flow Nebulizer (Teflon, 2/pk)

P/N : G1820-65119

The port with the ferrule connects with the makeup gas line tubing, the other port should be firmly connected into the luer type connector.



Sample Tube Kit for Cross Flow Nebulizer

P/N : G1820-65141

Description :

PFA Tubing for Connecting the Platinum Tubing

(0.6mm id, 1.1mm od, 150mm)

Tygon Tubing (100mm)

PFA Tubing (0.5mm id, 1.6mm od)

Cut the PFA tubing for the connection to the platinum tubing to approx. 30mm, and connect to the end cap (insert over the platinum tubing). Cut the other PFA tubing to the appropriate length and connect using the Tygon tubing (see photo).

Agilent 7500 Series ICP-MS Customer Maintenance Parts List
Parts Related to the Nebulizer

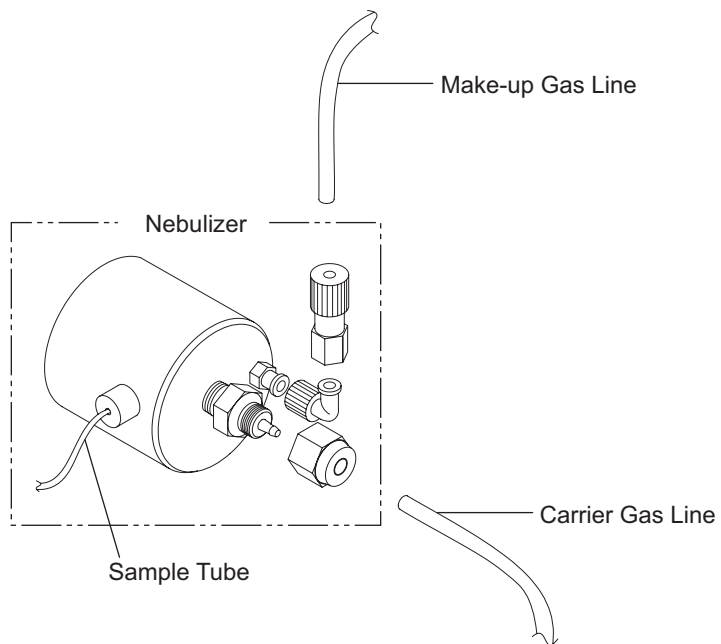

Figure: Cross Flow Nebulizer, Fittings and Tubes

Miscellaneous parts for Nebulizer



O-rings for End Cap (Viton O-rings, 5/pk)
P/N : G1820-65198

O-rings for Organic Solvents
P/N : G1820-65518, for End Cap, 2/pk
G1820-65520, for Concentric Nebulizer, 3 types,
4/pk



Connector for End Cap and Gas Line (PPS)
P/N : 5063-5263

Usage :
Connecting the Nebulizer with the Makeup Gas Line Tubing
(Babington/Concentric Nebulizer)
Connecting the Nebulizer with the Carrier Gas Line Tubing
(Cross Flow Nebulizer)
Gas Line Connector for Agilent 7500



Tubing for Carrier/Makeup Gas Line
(PTFE, 3.0mm id, 4.0mm od, 350mm, 2/pk)
P/N : G1833-65414

This tubing is used to connect the carrier/makeup gas line of the Agilent 7500 to the nebulizer.

Agilent 7500 Series ICP-MS Customer Maintenance Parts List
Parts Related to the Nebulizer



**Inner Sleeve for Carrier/Makeup/Auxiliary Gas Lines
(CTFE, 5/pk)**

P/N : 5042-0922

The inner sleeve is needed to maintain a gas tight seal.

Usage :

Connecting the Nebulizer with the Carrier Gas Line Tubing
(Babington/Concentric Nebulizer)

Connecting the Nebulizer with the Makeup Gas Line Tubing
(Cross Flow Nebulizer)

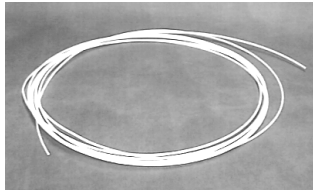

Sample Tubing (PFA)

P/N : G1820-65105 0.5mm id, 1.6mm od, 5m

G1820-65009 0.5mm id, 1.6mm od, 3m

G1820-65478 0.3mm id, 1.6mm od, 3m

G1820-65478 is used for Online ISTD Addition.

Sample Tubing (PFK, 700mm, 3/pk)

P/N : G1833-65572, 0.15mm id, 1.6mm od

G1833-65573, 0.2mm id, 1.6mm od

**Sample Tubing with PEEK guide
(PFA, 700mm, 5/pk)**

P/N : G1820-65526, 0.15mm id, 1.6mm od

G1820-65527, 0.2mm id, 1.6mm od

G1820-65531, 0.3mm id, 1.6mm od

Agilent 7500 Series ICP-MS Customer Maintenance Parts List
Parts Related to the Nebulizer

Parts Related to the Spray Chamber

Parts Related to the Spray Chamber

Parts Related to the Spray Chamber

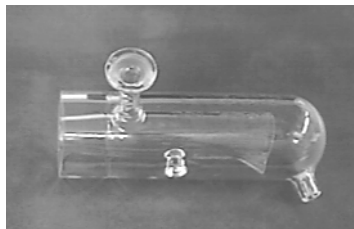

Spray Chamber (Quartz)

P/N : G1820-65337

This quartz spray chamber is the standard spray chamber for the Agilent 7500. This spray chamber should not be used with hydrofluoric acid.



Spray Chamber (Polypropylene, Sapphire Tube)

P/N : G1833-65463

This polypropylene spray chamber is the standard spray chamber for the inert sample introduction kit, and is used for introducing hydrofluoric acid.



Connector (Quartz)

P/N : G1833-65426

This connector is used to connect the quartz spray chamber to the torch.



Connector (Polypropylene)

P/N : G1833-65464

This connector is used to connect the polypropylene spray chamber to the torch and is used for introducing hydrofluoric acid. O-rings (G1833-65480) are also required to seal the connection, to the spray chamber and the injector of the inert torch.

Agilent 7500 Series ICP-MS Customer Maintenance Parts List
Parts Related to the Spray Chamber



**O-ring for Polypropylene Connector
(Viton O-ring, 1/pk)
P/N : G1833-65480**

This o-ring is used to connect the polypropylene connector to the spray chamber and the injector of the inert torch.



**Connector for Optional Gas Introduction (Quartz)
P/N : G1833-65427**

This connector is used to mix the optional gas with the carrier gas (e.g. oxygen gas introduction when using organic solvent). To connect to the optional gas line, the same connector as used for the auxiliary gas line connection is required (G1820-65027).



**Clamps (2/pk)
P/N : G1833-65430**

The clamps are used to clamp the connector to the spray chamber and torch.

Agilent 7500 Series ICP-MS Customer Maintenance Parts List
Parts Related to the Spray Chamber

Parts Related to the Torch

Parts Related to the Torch

Parts Related to the Torch

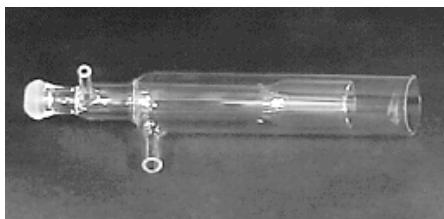

Torch (Quartz)

P/N : G1833-65423, 2.5mm id

G1833-65424, 1.5mm id, Taper Type

G1833-65425, 1.0mm id, Taper Type

Photo : G1833-65423

The torch (2.5mm id) is the standard torch for the Agilent 7500. The torch (taper type) is used for introducing organic solvent, etc. These torches cannot be used for introducing hydrofluoric acid.



Inert Torch (without Injector, Quartz)

P/N : G1833-65422

This torch is used with the platinum or sapphire injector for the inert torch assembly. The inert torch assembly is used for introducing hydrofluoric acid.



Injector for Inert Torch

P/N : G1833-65409, Platinum, 2.0mm id

G1833-65415, Platinum, 2.5mm id

G1833-65416, Platinum, 1.5mm id

G1833-65410, Sapphire, 2.0mm id

Photo : G1833-65409

This injector is used with the inert torch for the inert torch assembly. The inert torch assembly is used for introducing hydrofluoric acid.

Agilent 7500 Series ICP-MS Customer Maintenance Parts List

Parts Related to the Torch



Long Life Shield Plate

P/N : G1833-65419

This shield plate uses different materials that extend the operational lifetime.



Bonnet (Quartz Ring for Shield Torch)

P/N : G1833-65421



Work Coil

P/N : G1833-65432



Tubing for the Plasma/Auxiliary Gas Line (Polyurethane)

P/N : G3270-65021

These tubes are used to connect the plasma gas and auxiliary gas lines to the torch.

Description :

Tubing for Plasma Gas Line (Tubing, 4mm id, 350mm)

Tubing for Auxiliary Gas Line (Tubing, 2.5mm id, 350mm)

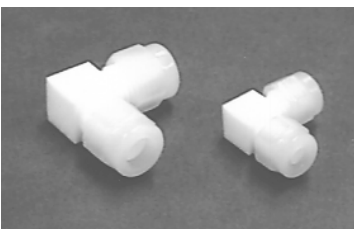

Connector for Plasma/Auxiliary Gas

(Body : PTFE, Nut : ECTFE, 1/pk each)

P/N : G1820-65027

These connectors are used to connect the plasma gas and auxiliary gas lines to the torch.

Agilent 7500 Series ICP-MS Customer Maintenance Parts List

Parts Related to the Torch



Inner Sleeve (CTFE)

P/N : 5042-0922, for Carrier/Makeup/Auxiliary Gas Lines, 5/pk

5042-0923, for Plasma Gas Line, 5/pk

The inner sleeve is needed to maintain a gas tight seal.

Parts Related to the Interface

Parts Related to the Interface

Parts Related to the Interface

Interface and Skimmer Base Conformity Chart

Part number	Specifications	7500a	7500i	7500s	7500c	7500ce	7500cs	T-mode
Sampling cone								
G1820-65238	Nickel	●	●	▲	●	●	▲	–
G1820-65239	Platinum (10 mm insert)	▲	▲	●	▲	▲	●	–
G1820-65360	Platinum (18 mm insert)	▲	▲	▲	▲	▲	▲	–
G1820-65480	Nickel, for T-mode	T-mode	T-mode	T-mode	–	–	–	▲
Skimmer cone								
G1820-65050	Nickel	●	●	▲	–	–	–	–
G1833-65497	Nickel	–	–	–	●	–	▲	–
G3270-65024	Nickel	–	–	–	–	●	–	–
G1820-65237	Base: Copper, Tip: Platinum	▲	▲	●	–	–	–	–
G1833-65092	Base: Copper, Tip: Platinum	–	–	–	▲	–	–	–
G1833-65132	Base: Copper, Tip: Platinum	–	–	–	–	▲	●	–
G3270-60106	Base: Nickel, Tip: Platinum	–	–	–	–	–	▲	–
G1820-65481	Nickel, for T-mode	T-mode	T-mode	T-mode	–	–	–	▲
Skimmer base								
G1833-65407	Stainless steel, for nickel skimmer cone	●	●	▲	–	–	–	▲
G1833-65498	Stainless steel, for nickel skimmer cone	–	–	–	●	–	–	–
G1833-65591	Stainless steel, for nickel skimmer cone	–	–	–	–	●	▲	–
G1833-65408	Brass, for platinum skimmer cone	▲	▲	●	–	–	–	–
G1833-65505	Brass, for platinum skimmer cone	–	–	–	▲	–	–	–
G1833-65590	Brass, for platinum skimmer cone	–	–	–	–	▲	●	–

● : Standard (when instrument shipped from factory) ▲ : Available part – : Cannot be used
 T-mode: 7500a, 7500i, 7500s with T-mode specifications

NOTE

18mm platinum cone insert (G1820-65360) is recommended for measuring H₂SO₄ above 2%.
 Platinum cones cannot be used for T-mode.
 T-mode is not used with ORS models.

Parts Related to the Interface



Sampling Cone with O-ring

P/N : G1820-65238, Ni Sampling Cone
G1820-65239, Pt Sampling Cone (10mm Insert)
G1820-65360, Pt Sampling Cone (18mm Insert)
G1820-65480, Ni Sampling Cone

Photo : G1820-65238

Application must refer to “Interface and Skimmer Base Conformity Chart”.

G1820-65238 :

The Nickel sampling cone is used as the standard interface of the Agilent 7500a, i, c, ce. This sampling cone is relatively robust to samples containing high concentrations of matrix and salts, and is suitable for a wide variety of samples. It is usually used with the Nickel skimmer cone.

G1820-65239 :

The Platinum sampling cone is used as the standard interface of the Agilent 7500s, cs. It is usually used for introduction of hydrofluoric acid and other reagents. It is usually used with the Platinum skimmer cone.

G1820-65360 :

The Platinum sampling cone (18mm tip) is used for reagents with high viscosity and high boiling points such as sulfuric acid, phosphoric acid, etc. It is usually used with the Platinum skimmer cone.

G1820-65480 :

This sampling cone is used for the T-mode option only. It is used with the Nickel skimmer cone for T-mode.



O-ring for Sampling Cone
(Viton O-ring, Teflon Coating)

P/N : G1820-65025

Parts Related to the Interface



Skimmer Cone

P/N : G1820-65050, Ni Skimmer Cone
G1833-65497, Ni Skimmer Cone
G3270-65024, Ni Skimmer Cone
G1820-65237, Copper base Pt Skimmer Cone
G1833-65092, Copper base Pt Skimmer Cone
G1833-65132, Copper base Pt Skimmer Cone
G3270-60106, Nickel base Pt Skimmer Cone
G1820-65481, Ni Skimmer Cone

Photo : G1820-65050

Application must refer to “Interface and Skimmer Base Conformity Chart”.

G1820-65050 :

The Nickel skimmer cone is used as the standard interface of the Agilent 7500a, i. This skimmer cone is relatively robust to samples containing high concentrations of matrix and salts, and is suitable for a wide variety of samples. It is usually used with the Nickel sampling cone. It can be used with the 7500a, 7500i, and 7500s.

G1820-65237 :

The Platinum skimmer cone is usually used for introduction of hydrofluoric acid and other reagents for the 7500s. It is usually used with the Platinum sampling cone. It can be used with the 7500a, 7500i, and 7500s.

G1820-65481 :

This skimmer cone is used for the T-mode option only. It is used with the Nickel sampling cone for T-mode.

G1833-65497 :

This is used for the 7500c. It is used with the Nickel sampling cone (G1820-65238).

G3270-65024:

This Skimmer Cone is used as the standard interface for the 7500ce. It is used for the 7500ce only and it is used with the Nickel Sampling Cone (G1820-65238).

G1833-65132 :

This Platinum skimmer cone is used as the standard interface of the 7500cs. It can be used for the 7500ce and the 7500cs. It is used with the Platinum sampling cone (G1820-65239 or G1820-65360).

Agilent 7500 Series ICP-MS Customer Maintenance Parts List

Parts Related to the Interface

CAUTION



The Platinum Skimmer cone must be mounted on the Brass skimmer base; otherwise the copper base of the skimmer cone will deteriorate and shorten the lifetime of the skimmer cone itself.

	Platinum Skimmer Cone	Brass Skimmer Base
7500a	G1820-65237	G1833-65408
7500ce/cs	G1833-65132	G1833-65590



Sampling Cone Removal Wrench

P/N : G1833-65405

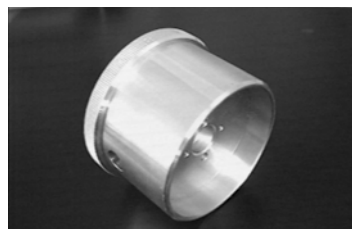

Skimmer Cone Removal Wrench

P/N : G1833-65079



Citranox

P/N : 5188-5359

Agilent 7500 Series ICP-MS Customer Maintenance Parts List
Parts Related to the Interface

**Parts Related to the Ion Lens and
Vacuum Chamber**

Agilent 7500 Series ICP-MS Customer Maintenance Parts List
Parts Related to the Ion Lens and Vacuum Chamber

Parts Related to the Ion Lens and Vacuum Chamber

Interface and Skimmer Base Conformity Chart

Part number	Specifications	7500a	7500i	7500s	7500c	7500ce	7500cs	T-mode
Sampling cone								
G1820-65238	Nickel	●	●	▲	●	●	▲	–
G1820-65239	Platinum (10 mm insert)	▲	▲	●	▲	▲	●	–
G1820-65360	Platinum (18 mm insert)	▲	▲	▲	▲	▲	▲	–
G1820-65480	Nickel, for T-mode	T-mode	T-mode	T-mode	–	–	–	▲
Skimmer cone								
G1820-65050	Nickel	●	●	▲	–	–	–	–
G1833-65497	Nickel	–	–	–	●	–	▲	–
G3270-65024	Nickel	–	–	–	–	●	–	–
G1820-65237	Base: Copper, Tip: Platinum	▲	▲	●	–	–	–	–
G1833-65092	Base: Copper, Tip: Platinum	–	–	–	▲	–	–	–
G1833-65132	Base: Copper, Tip: Platinum	–	–	–	–	▲	●	–
G3270-60106	Base: Nickel, Tip: Platinum	–	–	–	–	–	▲	–
G1820-65481	Nickel, for T-mode	T-mode	T-mode	T-mode	–	–	–	▲
Skimmer base								
G1833-65407	Stainless steel, for nickel skimmer cone	●	●	▲	–	–	–	▲
G1833-65498	Stainless steel, for nickel skimmer cone	–	–	–	●	–	–	–
G1833-65591	Stainless steel, for nickel skimmer cone	–	–	–	–	●	▲	–
G1833-65408	Brass, for platinum skimmer cone	▲	▲	●	–	–	–	–
G1833-65505	Brass, for platinum skimmer cone	–	–	–	▲	–	–	–
G1833-65590	Brass, for platinum skimmer cone	–	–	–	–	▲	●	–

● : Standard (when instrument shipped from factory) ▲ : Available part – : Cannot be used
T-mode: 7500a, 7500i, 7500s with T-mode specifications

NOTE

18mm platinum cone insert (G1820-65360) is recommended for measuring H₂SO₄ above 2%.
Platinum cones cannot be used for T-mode.
T-mode is not used with ORS models.

Agilent 7500 Series ICP-MS Customer Maintenance Parts List
Parts Related to the Ion Lens and Vacuum Chamber



Skimmer Base with Screws

P/N : G1833-65407, Stainless Steel
G1833-65408, Brass
G1833-65498, Stainless Steel
G1833-65505, Brass
G1833-65591, Stainless Steel
G1833-65590, Brass

Photo : G1833-65407

Application must refer to “Interface and Skimmer Base Conformity Chart”.

G1833-65407 :

The Stainless steel skimmer base is used as the standard skimmer base for the Agilent 7500a. It is used to hold the Nickel skimmer cone.

G1833-65408 :

The Brass skimmer base is used to hold the Platinum skimmer cone.

G1833-65498 :

The Stainless steel skimmer base is used to hold the Nickel skimmer cone for the Agilent 7500c.

G1833-65505 :

The Brass skimmer base is used to hold the Platinum skimmer cone for the Agilent 7500c.

G1833-65591:

The Stainless steel skimmer base is used to hold the Nickel skimmer cone for the Agilent 7500ce.

G1833-65590:

The Brass skimmer base is used to hold the Platinum skimmer cone for the Agilent 7500cs.



Skimmer Base Screws (4/pk)

P/N : G1820-65435

Agilent 7500 Series ICP-MS Customer Maintenance Parts List
Parts Related to the Ion Lens and Vacuum Chamber



Extraction Lens 1
P/N : G1833-65417



Extraction Lens 2
P/N : G1833-65413



Extraction Lens Screw Kit
P/N : G1833-65024



Omega Lens Assembly
P/N : G1833-65418



Omega Lens Screw Kit
P/N : G1833-65025

Agilent 7500 Series ICP-MS Customer Maintenance Parts List
Parts Related to the Ion Lens and Vacuum Chamber

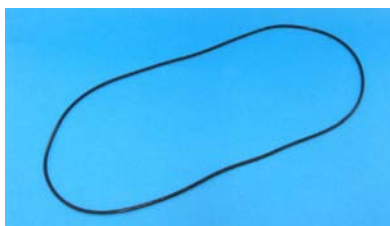

Plate Bias

P/N : G1833-65444 (for Slim Ring Type Quadrupole)

P/N : G1833-65494 (for Eagle Type Quadrupole)

Photo: G1833-65444



O-ring for Vacuum Chamber (Viton O-ring)

P/N : 5042-0901



O-rings for Vent Valve (Viton O-ring, 2/pk)

P/N : G1833-65332

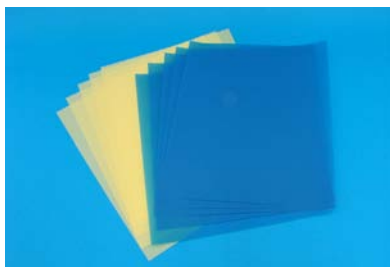

Polishing Paper Kit (#400/#1200, 5 sheets each)

P/N : G1833-65404

The polishing paper is waterproof and is used to clean the ion lenses and the interface cones.

Agilent 7500 Series ICP-MS Customer Maintenance Parts List
Parts Related to the Ion Lens and Vacuum Chamber



Electron Multiplier

P/N : 5184-1983 (S/N ~JP14100586)

G1833-65575 (S/N JP14100587~)

There are two types of electron multiplier: ETP and HPK. Order P/N G1833-65575 for instruments with the label "HPK Installed" (S/N JP14100587 and later), and P/N 5184-1983 for instruments without such a label (S/N JP14100586 and earlier). The two types of electron multipliers have similar performance, but as the tuning conditions are different, using the same type of electron multiplier is recommended. The electron multiplier detector should be replaced when either the Analog HV exceeds 3300v or the pulse HV exceeds 1800v.



Penning Gauge Body Tube

P/N : G1820-81012

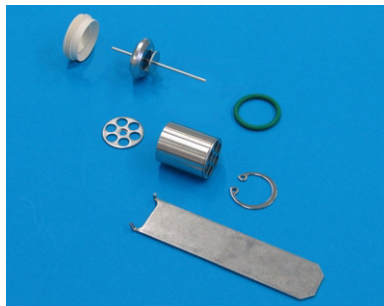

Penning Gauge Electrode Kit

P/N : G1820-81013

Parts Related to the 7500ce

Parts Related to the 7500ce



Extraction Lens 1
P/N: G3270-65028



Extraction Lens 2
P/N: G3270-65029



Omega Lens-ce
P/N: G3270-65030



Omega Bias-ce
P/N: G3270-65031

Agilent 7500 Series ICP-MS Customer Maintenance Parts List
Parts Related to the 7500ce



Cell Focus Lens
P/N: G1833-65597



Cell Entrance Lens with O-ring
P/N: G1833-65598



QP Focus Lens with O-ring
P/N: G1833-65599



Cell Exit Lens
P/N: G1833-66000

Agilent 7500 Series ICP-MS Customer Maintenance Parts List
Parts Related to the 7500ce

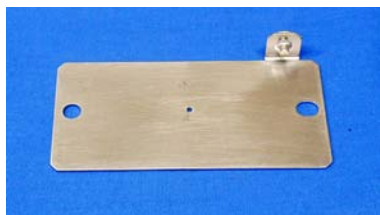

Plate Bias
P/N : G1833-65513 (S/N JP14100050 ~ JP14100313)
G1833-65562 (S/N JP14100314 ~)

Check equipment S/N when placing an order.



Octopole (without Cell Entrance/Exit, QP Focus and O-ring)
P/N: G1833-65133



Octopole Assembly (Cell Focus, Cell Entrance/Exit and QP Focus, without O-ring)
P/N: G1833-65134



Reaction Cell Assembly
P/N: G1833-66001



Extraction-Omega Lens Assembly
P/N: G3270-65023

Agilent 7500 Series ICP-MS Customer Maintenance Parts List

Parts Related to the 7500ce



Extraction and Omega Lens Screw and Spacer Kit

P/N: G3270-60639

Contents:

Spacer (No lip) (QTY 2)

Spacer (lipped) (QTY 8)

Guide (lipped) (QTY 1)

Lens Screw (QTY 3)

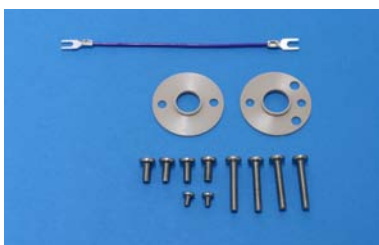

Reaction Cell Screw and Spacer Kit

P/N: G1833-65138

Contents:

Spacer (for Cell Focus, Cell Entrance) (QTY 1)

Spacer (for QP Focus, Cell Exit) (QTY 1)

Cable for Plate Bias (QTY 1)

Cell assembly Screws (QTY 4)

Cell Entrance/Exit Lens Screws (QTY 4)

Plate Bias cable screws (QTY 2)



O-ring (2/pk)

P/N: G1833-66035



Reaction Gas Tubing (2/pk)

P/N: G1833-65089



Cotton Swabs, ultra-fine conical bud shape at both ends (100/pk)

P/N: 9300-2574

Agilent 7500 Series ICP-MS Customer Maintenance Parts List
Parts Related to the 7500ce



Alumina Powder
P/N : 8660-0791

Parts Related to the 7500cs

Parts Related to the 7500cs



Extraction Lens 1
P/N: G1833-65592



Extraction Lens 2
P/N: G1833-65593



Omega Bias-cs
P/N: G1833-65594



Omega Lens-cs
P/N: G1833-65595

Agilent 7500 Series ICP-MS Customer Maintenance Parts List
Parts Related to the 7500cs



Cell Focus Lens
P/N: G1833-65597



Cell Entrance Lens with O-ring
P/N: G1833-65598



QP Focus Lens with O-ring
P/N: G1833-65599



Cell Exit Lens
P/N: G1833-66000

Agilent 7500 Series ICP-MS Customer Maintenance Parts List
Parts Related to the 7500cs

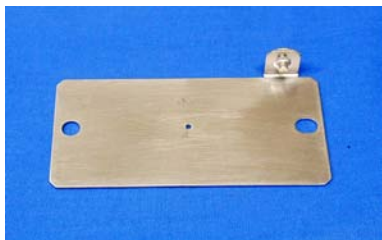
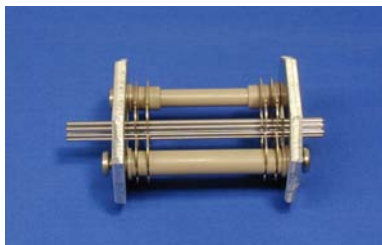

Plate Bias
P/N : G1833-65513 (S/N JP14100050 ~ JP14100313)
G1833-65562 (S/N JP14100314 ~)

Check equipment S/N when placing an order.



Octopole (Without Cell Entrance/Exit, QP Focus and O-ring)
P/N: G1833-65133



Octopole Assembly (Cell Focus, Cell Entrance/Exit and QP Focus, without O-ring)
P/N: G1833-65134



Reaction Cell Assembly
P/N: G1833-66001



Extraction-Omega Lens Assembly
P/N: G1833-65596

Agilent 7500 Series ICP-MS Customer Maintenance Parts List

Parts Related to the 7500cs



Extraction and Omega Lens Screw and Spacer Kit

P/N: G1833-65125

Contents:

Spacer (No lip) (QTY 2)

Spacer (Lipped) (QTY 8)

Guide (Lipped) (QTY 1)

Lens Screw (QTY 3)



Reaction Cell Screw and Spacer Kit

P/N: G1833-65138

Contents:

Spacer (for Cell Focus, Cell Entrance) (QTY 1)

Spacer (for QP Focus, Cell Exit) (QTY 1)

Cable for Plate Bias (QTY 1)

Cell assembly Screws (QTY 4)

Cell Entrance/Exit Lens Screws (QTY 4)

Plate Bias cable screws (QTY 2)



O-ring (2/pk)

P/N: G1833-66035



Reaction Gas Tubing (2/pk)

P/N: G1833-65089

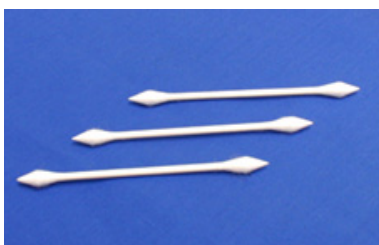

Cotton Swab, ultra-fine conical bud shape at both ends (100/pk)

P/N: 9300-2574

Agilent 7500 Series ICP-MS Customer Maintenance Parts List
Parts Related to the 7500cs



Alumina Powder
P/N : 8660-0791

Miscellaneous Components

Miscellaneous Components

Miscellaneous Components



Plastic Tray
P/N : G1833-65412



Gas Filter
P/N : G1833-65581

Ar Gas Tubing with Filter (can be used for Option Gas Line)

P/N : G1820-65023

Triple Filter Cartridge

P/N : 5182-9705

Replacement O-rings for Gas Filters

P/N : 5182-3423



Strainer for Cooling Water

P/N: G1833-66024

Agilent 7500 Series ICP-MS Customer Maintenance Parts List
Miscellaneous Components



Cooling Water Hose (10m)
P/N : G1833-65429



Rotary Pump Oil
P/N : 6040-0834, 1L
6040-0798, 4L

The rotary pump for the Agilent 7500 requires approx. 1L of oil.



Oil Mist Filter Kit
P/N : 3162-1056



Oil Mist Filter Element
P/N : 1535-4970

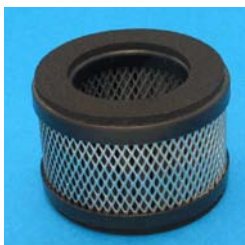

Odor Element for Oil Mist Filter (5/pk)
P/N : 5063-9153

Miscellaneous Components

Tuning Solution

P/N : 8500-6943, Stock Tuning Solution: Li, Y, Ce and Tl; 100 mL, 10 mg/L; matrix=2% HNO₃

5184-3566, Tuning Solution: Li, Y, Ce, Tl and Co; 2 x 500 mL, 10 µg/L; matrix= 2% HNO₃

5185-5959, Tuning Solution: Li, Mg, Y, Ce, Tl and Co; 2 x 500mL, 1 µg/L; matrix= 2% HNO₃

LC-ICP-MS Connection Kit

P/N : G1833-65200

Description :

Sample Tubing

Ferrule

Connector

Union

APG Remote Cable

Gender Changer

APG Remote Cable (5 m)

P/N : 5064-8046

As Speciation Column

P/N : G3154-65001

Guard Column for As Speciation

P/N : G3154-65002

**Parts related to the Integrated Sample
Introduction System (ISIS)**

Parts Related to the Integrated Sample Introduction System (ISIS)

Tubing kit

P/N : G3138-65023 Tubing kit for High throughput

P/N : G3138-65024 Tubing kit for Autodilution

P/N : G3138-65025 Tubing kit for Discrete Sampling

Tubing kit is assembled for each configuration.



Joint Holder

P/N : G3138-65102, for ICP-MS Pump

G3138-65103, for ISIS Pump

Used to hold the joints.

Sample Line Connector

P/N : G3138-65104



Valve Rotor Seal

P/N : G3138-65117



Valve Nut (6/pk)

P/N : G3138-65118

Agilent 7500 Series ICP-MS Customer Maintenance Parts List
Parts related to the Integrated Sample Introduction System (ISIS)



Valve Ferrule (6/pk)
P/N : G3138-65119

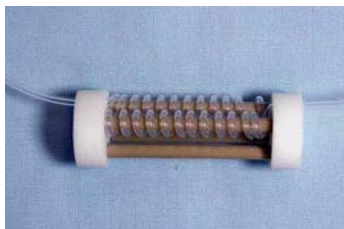

Mixer
P/N : G3138-65121



Sample Loop (100 μ L)
P/N : G3138-65122

Tubing Adapter
P/N : G3138-65126

Between ISTD peripump tubing/teflon tubing.



Tubing Adapter
P/N : G3138-65158

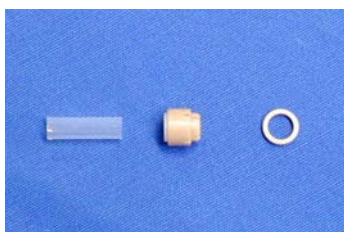

Ferrule and Tubing (10/pk)
P/N : G3138-65157

Agilent 7500 Series ICP-MS Customer Maintenance Parts List
Parts related to the Integrated Sample Introduction System (ISIS)

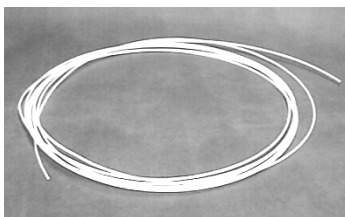

Sample Tubing

P/N : G1820-65105, PFA, 0.5mm id, 1.6mm od, 5m
G1820-65478, PFA, 0.3mm id, 1.6mm od, 3m
5064-8016, ETFE, 0.8mm id, 1.6mm od, 5m
5064-8020, PTFE, 2.0mm id, 3.0mm od, 5m

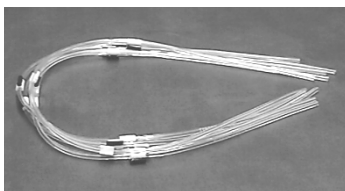

Peristaltic Pump Tubing for ICP-MS Pump

P/N : 5064-8014
Tygon Tubing, 0.89mm id, 3 stoppers, 12/pk
5064-8034
Tygon Tubing, 0.25mm id, 3 stoppers, 12/pk



Peristaltic Pump Tubing for ISIS Pump

P/N : 5064-8015
Tygon Tubing, 0.25mm id, 2 stoppers, 12/pk
5064-8028
Tygon Tubing, 1.02mm id, 2 stoppers, 12/pk



Tee Joint

P/N : 5064-8017



Cross Joint

P/N : 5064-8018

Agilent 7500 Series ICP-MS Customer Maintenance Parts List
Parts related to the Integrated Sample Introduction System (ISIS)



Union Joint
P/N : 5064-8019



Teflon Nut (10/pk)
P/N : 5064-8021, for 3.0mm od Tubing
5064-8023, for 1.6mm od Tubing



Front and Back Ferrule
P/N : 5064-8022, for 3.0mm od Tubing
5064-8024, for 1.6mm od Tubing



Peristaltic Pump Tubing Adapter
P/N : 5064-8026

This adapter is used to connect the peristaltic pump tubing and sample tubing. Use the appropriate nut and ferrule to connect sample tubing.



Tubing Clamp (Small : 10/pk, Large : 5/pk)
P/N : 5064-8027

Agilent 7500 Series ICP-MS Customer Maintenance Parts List
Parts related to the Integrated Sample Introduction System (ISIS)



Spiral Tubing (5m)
P/N : 5064-8029



Valve Maintenance Wrench
P/N : 5064-8032



Tubing Identification Tag (10/pk)
P/N : 5064-8033

Parts Related to the Hydride Generator Accessory

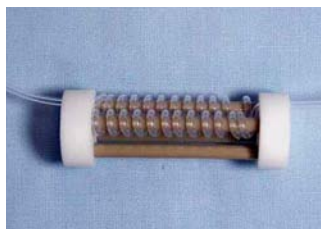

Mixer
P/N : G3138-65121

Peristaltic Pump Tubing
(ismaprene, for ISIS pump, 2.54mm id, 2 stoppers,
6 pack)
P/N : G3138-65128



Cross Joint Plug (3/pk)
P/N : G3138-65129

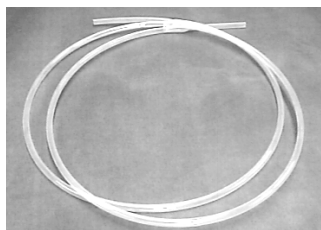

Gas Line Tubing (PTFE, 3.0mm id, 4.0mm od, 5m)
P/N : G3138-65138



Reducing Union Connector
P/N : G3138-65139, 6mm × 3mm
G3138-65140, 6mm × 4mm
G3138-65144, 8mm × 4mm

Agilent 7500 Series ICP-MS Customer Maintenance Parts List
Parts related to the Integrated Sample Introduction System (ISIS)



Gas/Liquid Separator Set

P/N : G3138-65130

Description :

Separator Gas Chamber
Filter O-ring
Separator Holder
Exclusive Concentric Nebulizer
Nebulizer O-ring, 2/pk
Cyclone Chamber
Filter, 5/pk

Separator Gas Chamber

P/N : G3138-65131

Filter O-ring

P/N : G3138-65132

Separator Holder

P/N : G3138-65133

Exclusive Concentric Nebulizer

P/N : G3138-65134

Nebulizer O-ring (2/pk)

P/N : G3138-65135

Cyclone Chamber

P/N : G3138-65136

Filter (10/pk)

P/N : G3138-65137

Agilent 7500 Series ICP-MS Customer Maintenance Parts List
Parts related to the Integrated Sample Introduction System (ISIS)



Plug for Carrier Gas Connector (4.0mm od, 3/pk)
P/N : G3138-65141



Y Connector (5/pk)
P/N : G3138-65143



Inner Sleeve for 3.0mm id Tubing (CTFE, 5/pk)
P/N : 5042-0922

The inner sleeve is needed to maintain a gas tight seal..

Agilent 7500 Series ICP-MS Customer Maintenance Parts List
Parts related to the Integrated Sample Introduction System (ISIS)

**Parts Related to the GC-ICP-MS
Interface**

Agilent 7500 Series ICP-MS Customer Maintenance Parts List
Parts Related to the GC-ICP-MS Interface

Parts Related to the GC-ICP-MS Interface



Transfer Line
P/N : G3158-65000



Injector
P/N : G3158-65001



Stainless Steel Pipe (1/16in, with connector)
P/N : G3158-65002



Silico Steel Pipe (1/16in)
P/N : G3158-65003

Agilent 7500 Series ICP-MS Customer Maintenance Parts List
Parts Related to the GC-ICP-MS Interface

Ferrule Kit

P/N : G3158-65004

Description:

Reducer Ferrule (1/8in to 1/16in, 2/pk)
Graphite Ferrule (320um, 0.5mm id, 2/pk)
Vespel-Graphite Ferrule (1/4in, 2/pk)
Vespel-Graphite Ferrule (1/16in, 2/pk)



Graphite Ferrule (320um, 0.5mm id, 10/pk)

P/N : G3158-65005



Xe Gas Mixture Tee Union

P/N : G3158-65006



Torch for GC-ICP-MS Interface

P/N : G3158-65007



Alignment Boss

P/N : G3158-65008

Agilent 7500 Series ICP-MS Customer Maintenance Parts List
Parts Related to the GC-ICP-MS Interface

**Parts Related to the Integrated Auto
Sampler (I-AS)**

Parts Related to the Integrated Auto Sampler (I-AS)

Parts Related to the I-AS (Integrated Auto Sampler)

Tray, Vial Set

P/N : G3160-65300 (Type A Tray, includes 200 × 6mL vials)

G3160-65301 (Type B Tray, includes 55 × 18mL vials)

G3160-65302 (Type C Tray, includes 20 × 50mL vials)

G3160-65308 (Type D Tray, includes 200 × 2mL vials and 10 × 18mL vials)

G3160-65309 (Type E Tray, includes 200 × 6mL vials and 10 × 18mL vials)

Type A Tray : 89 positions for 6mL vials

Type B Tray : 53 positions for 18mL vials

Type C Tray : 8 positions for 50mL vials

Type D Tray : 79 positions for 2mL vials + 10 positions for 18mL vials

Type E Tray : 79 positions for 6mL vials + 10 positions for 18mL vials



Tray

P/N : G3160-65310, Type A Tray

G3160-65311, Type B Tray

G3160-65312, Type C Tray

G3160-65313, Type D Tray

G3160-65314, Type E Tray

Photo : G3160-65310

G3160-65310

Type A Tray-89 position for 6mL vial

G3160-65311

Type B Tray-53 position for 18mL Vial

Agilent 7500 Series ICP-MS Customer Maintenance Parts List
Parts Related to the Integrated Auto Sampler (I-AS)

G3160-65312

Type C Tray-18 position for 50mL Vial

G3160-65313

Type D Tray - 79 position for 2mL (or 1.5mL) vial and 10 position for 18mL vial

G3160-65314

Type E Tray - 79 position for 6mL vial and 10 position for 18mL vial

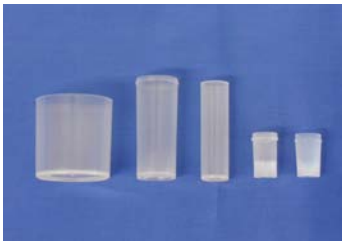

Vial

P/N : G3160-65303

6mL vial (Polypropylene), 200 pieces

P/N : G3160-65304

18mL vial (Polypropylene), 55 pieces

P/N : G3160-65305

50mL vial (Polypropylene), 20 pieces

P/N : G3160-65315

2mL vial (Polyethylene), 200 pieces

P/N : G3160-65317

1.5mL vial (PFA), 10 pieces

G3160-65303

for type A, E Tray

G3160-65304

for type B, D, E, Tray

G3160-65305

for type C Tray

G3160-65315

for type D Tray

G3160-65317

for type D Tray

Agilent 7500 Series ICP-MS Customer Maintenance Parts List
Parts Related to the Integrated Auto Sampler (I-AS)



Probe

P/N : G3160-65306 (0.3mm id)
G3160-65324 (0.8mm id)



Tray Cover

P/N : G3160-65321



Rinse Fluid Inlet/Outlet Tube

P/N : G3160-65320

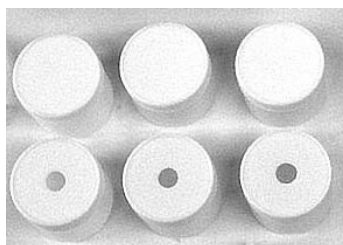

External Bottle

P/N : G3160-65307

100mL Bottles (with cap (QTY3), with holed cap (QTY3))

Parts Related to the Integrated Auto Sampler (I-AS)



Peristaltic Pump Tubing Set (With Connectors)

P/N : G3160-65326 (1 Set)

G3160-65327 (5 Set)

Peristaltic Pump Tubing for I-AS

Rinse Tubing (Tygon)

P/N : G3160-65328 (2 Pieces)

Tubing for Peristaltic Pump Tubing to Rinse Bottle and Peristaltic Pump tubing to Drain Bottle.



TubeHolder(forI-AS)

P/N: G3160-65325

Use this adapter for connecting the 1.66mm sample tubing to the probe.

It is possible to use the sample tubes G1833-65572 (0.15mmid), G1833-65573 (0.2mmid), G1820-65478 (0.3mm id).

Needle Holder

P/N : G3160-80041

Arm

P/N : G3160-80044



Carry Holder for tray and tray cover

P/N : G3160-60015

Convenient holder for lifting and carrying the I-AS tray in combination with the tray cover.

Agilent 7500 Series ICP-MS Customer Maintenance Parts List
Parts Related to the Integrated Auto Sampler (I-AS)

**Parts Related to the ASX-500 Series
ICP-MS Autosampler**

Parts Related to the Agilent ASX-500 Series ICP-MS Autosampler

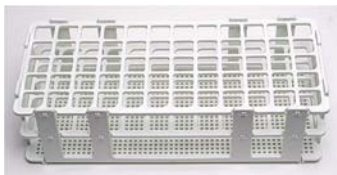

Sample Rack

P/N : G3286-80103 (21 positions, for 50 mL vials)
G3286-80104 (24 positions, for 30 mL vials)
G3286-80105 (40 positions, for 20 mL vials)
G3286-80106 (60 positions, for 14 mL vials)
G3286-80107 (90 positions, for 8 mL vials)

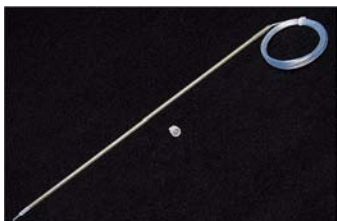

Sample Probe

P/N : G3286-80100 (0.8 mm id)
G3286-80101 (0.3 mm id)
G3286-80102 (0.5 mm id)



Rinse/Drain Tubing Hookup Kit

P/N : G3286-80117



PeriPump (drain) Tubing and Connector Kit (Tygon)

P/N : G3286-80118

Agilent 7500 Series ICP-MS Customer Maintenance Parts List
Parts Related to the ASX-500 Series ICP-MS Autosampler

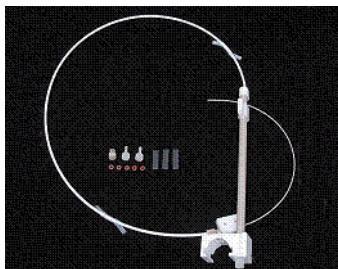

Z-Axis Drive Assembly
P/N : G3286-80200



Rinse Station
P/N : G3286-80224

Agilent 7500 Series ICP-MS Customer Maintenance Parts List
Parts Related to the ASX-500 Series ICP-MS Autosampler

INDEX

1535-4970	9-3	8710-1930.....	1-5
3162-1056	9-3	9300-2574.....	7-5, 8-5
5042-0901	6-5	G1820-60160.....	2-4
5042-0922	2-15, 4-4, 10-9	G1820-60453.....	2-2
5042-0923	4-4	G1820-65009.....	2-15
5042-4769	1-4	G1820-65016.....	1-4
5063-5263	2-14	G1820-65023.....	9-2
5063-9153	9-3	G1820-65025.....	5-3
5064-8014	10-4	G1820-65027.....	4-3
5064-8015	10-4	G1820-65030.....	2-4
5064-8016	10-4	G1820-65050.....	5-4
5064-8017	10-4	G1820-65052.....	2-4
5064-8018	10-4	G1820-65075.....	2-5
5064-8019	10-5	G1820-65105.....	2-15, 10-4
5064-8020	10-4	G1820-65119.....	2-12
5064-8021	10-5	G1820-65138.....	2-4
5064-8022	10-5	G1820-65141.....	2-12
5064-8023	10-5	G1820-65198.....	2-14
5064-8024	10-5	G1820-65199.....	2-3
5064-8026	10-5	G1820-65214.....	2-2
5064-8027	10-5	G1820-65237.....	5-4
5064-8028	10-4	G1820-65238.....	5-3
5064-8029	10-6	G1820-65239.....	5-3
5064-8032	10-6	G1820-65276.....	2-3
5064-8033	10-6	G1820-65337.....	3-2
5064-8034	10-4	G1820-65345.....	2-3
5064-8046	9-4	G1820-65360.....	5-3
5064-8078	2-10	G1820-65435.....	6-3
5182-3423	9-2	G1820-65478.....	2-15, 10-4
5182-9705	9-2	G1820-65480.....	5-3
5184-1983	6-6	G1820-65481.....	5-4
5184-3566	9-4	G1820-65482.....	1-4
5185-5959	9-4	G1820-65491.....	2-5
5188-5359	5-5	G1820-65503.....	1-4
6040-0798	9-3	G1820-65504.....	1-4
6040-0834	9-3	G1820-65505.....	1-4
8500-6943	9-4	G1820-65515.....	1-4
8660-0791	7-6, 8-6	G1820-65518.....	2-14

Agilent 7500 Series ICP-MS Customer Maintenance Parts List

INDEX

G1820-65520	2-14	G1833-65424	4-2
G1820-65526	2-15	G1833-65425	4-2
G1820-65527	2-15	G1833-65426	3-2
G1820-65531	2-15	G1833-65427	3-3
G1820-65533	2-3	G1833-65429	9-3
G1820-81012	6-6	G1833-65430	3-3
G1820-81013	6-6	G1833-65432	4-3
G1833-65024	6-4	G1833-65444	6-5
G1833-65025	6-4	G1833-65462	2-12
G1833-65071	1-3	G1833-65463	3-2
G1833-65079	5-5	G1833-65464	3-2
G1833-65089	7-5, 8-5	G1833-65475	2-4
G1833-65092	5-4	G1833-65476	2-2
G1833-65125	8-5	G1833-65477	2-12
G1833-65132	5-4	G1833-65480	3-3
G1833-65133	7-4, 8-4	G1833-65494	6-5
G1833-65134	7-4, 8-4	G1833-65497	5-4
G1833-65138	7-5, 8-5	G1833-65498	6-3
G1833-65200	9-4	G1833-65505	6-3
G1833-65332	6-5	G1833-65513	7-4, 8-4
G1833-65404	6-5	G1833-65562	7-4, 8-4
G1833-65405	5-5	G1833-65569	1-2
G1833-65407	6-3	G1833-65570	1-2
G1833-65408	6-3	G1833-65571	1-2
G1833-65409	4-2	G1833-65572	2-15
G1833-65410	4-2	G1833-65573	2-15
G1833-65411	1-4	G1833-65575	6-6
G1833-65412	9-2	G1833-65581	9-2
G1833-65413	6-4	G1833-65583	2-7
G1833-65414	2-14	G1833-65590	6-3
G1833-65415	4-2	G1833-65591	6-3
G1833-65416	4-2	G1833-65592	8-2
G1833-65417	6-4	G1833-65593	8-2
G1833-65418	6-4	G1833-65594	8-2
G1833-65419	4-3	G1833-65595	8-2
G1833-65421	4-3	G1833-65596	8-4
G1833-65422	4-2	G1833-65597	7-3, 8-3
G1833-65423	4-2	G1833-65598	7-3, 8-3

Agilent 7500 Series ICP-MS Customer Maintenance Parts List

INDEX

G1833-65599.....	7-3, 8-3	G3139-65005.....	2-7
G1833-66000.....	7-3, 8-3	G3139-65006.....	2-7
G1833-66001.....	7-4, 8-4	G3139A#011.....	2-6
G1833-66024.....	9-2	G3139A#012.....	2-6
G1833-66035.....	7-5, 8-5	G3139A#021.....	2-6
G3138-65023.....	10-2	G3139A#022.....	2-6
G3138-65024.....	10-2	G3139A#131.....	2-6
G3138-65025.....	10-2	G3139A#301.....	2-6
G3138-65102.....	10-2	G3154-65001.....	9-4
G3138-65103.....	10-2	G3154-65002.....	9-4
G3138-65104.....	10-2	G3158-65000.....	11-2
G3138-65117.....	10-2	G3158-65001.....	11-2
G3138-65118.....	10-2	G3158-65002.....	11-2
G3138-65119.....	10-3	G3158-65003.....	11-2
G3138-65121.....	10-3, 10-7	G3158-65004.....	11-3
G3138-65122.....	10-3	G3158-65005.....	11-3
G3138-65126.....	10-3	G3158-65006.....	11-3
G3138-65128.....	10-7	G3158-65007.....	11-3
G3138-65129.....	10-7	G3158-65008.....	11-3
G3138-65130.....	10-8	G3160-60015.....	12-5
G3138-65131.....	10-8	G3160-65300.....	12-2
G3138-65132.....	10-8	G3160-65301.....	12-2
G3138-65133.....	10-8	G3160-65302.....	12-2
G3138-65134.....	10-8	G3160-65303.....	12-3
G3138-65135.....	10-8	G3160-65304.....	12-3
G3138-65136.....	10-8	G3160-65305.....	12-3
G3138-65137.....	10-8	G3160-65306.....	12-4
G3138-65138.....	10-7	G3160-65307.....	12-4
G3138-65139.....	10-7	G3160-65308.....	12-2
G3138-65140.....	10-7	G3160-65309.....	12-2
G3138-65141.....	10-9	G3160-65310.....	12-2
G3138-65143.....	10-9	G3160-65311.....	12-2
G3138-65144.....	10-7	G3160-65312.....	12-2
G3138-65157.....	10-3	G3160-65313.....	12-2
G3138-65158.....	10-3	G3160-65314.....	12-2
G3139-65002.....	2-6	G3160-65315.....	12-3
G3139-65003.....	2-7	G3160-65317.....	12-3
G3139-65004.....	2-7	G3160-65320.....	12-4

Agilent 7500 Series ICP-MS Customer Maintenance Parts List

INDEX

G3160-65321	12-4	G3286-80100	13-2
G3160-65324	12-4	G3286-80101	13-2
G3160-65325	12-5	G3286-80102	13-2
G3160-65326	12-5	G3286-80103	13-2
G3160-65327	12-5	G3286-80104	13-2
G3160-65328	12-5	G3286-80105	13-2
G3160-80041	12-5	G3286-80106	13-2
G3160-80044	12-5	G3286-80107	13-2
G3161A#001	2-9	G3286-80117	13-2
G3161A#002	2-9	G3286-80118	13-2
G3266-80010	2-8	G3286-80200	13-3
G3266-80011	2-8	G3286-80224	13-3
G3266-80015	2-8		
G3266A#001	2-8		
G3270-60106	5-4		
G3270-60639	7-5		
G3270-65021	4-3		
G3270-65023	7-4		
G3270-65024	5-4		
G3270-65028	7-2		
G3270-65029	7-2		
G3270-65030	7-2		
G3270-65031	7-2		
G3285-80000	2-10		
G3285-80001	2-10		
G3285-80020	2-11		
G3285-80021	2-11		
G3285-80022	2-11		
G3285-80023	2-11		
G3285-80030	2-11		
G3285-80031	2-11		
G3285-80032	2-11		
G3285-80033	2-11		
G3285-80050	2-11		
G3285A#101	2-10		
G3285A#102	2-10		
G3285A#103	2-10		
G3285A#104	2-10		